

Aluminium Nozzle AL-25

Technical data

Material: HDPE
Weight: 2,3 g
Thread: 15 x 1,5
Dimensions: O 25 x 53 mm
Color: transparent
Packing unit: 2600 pcs box

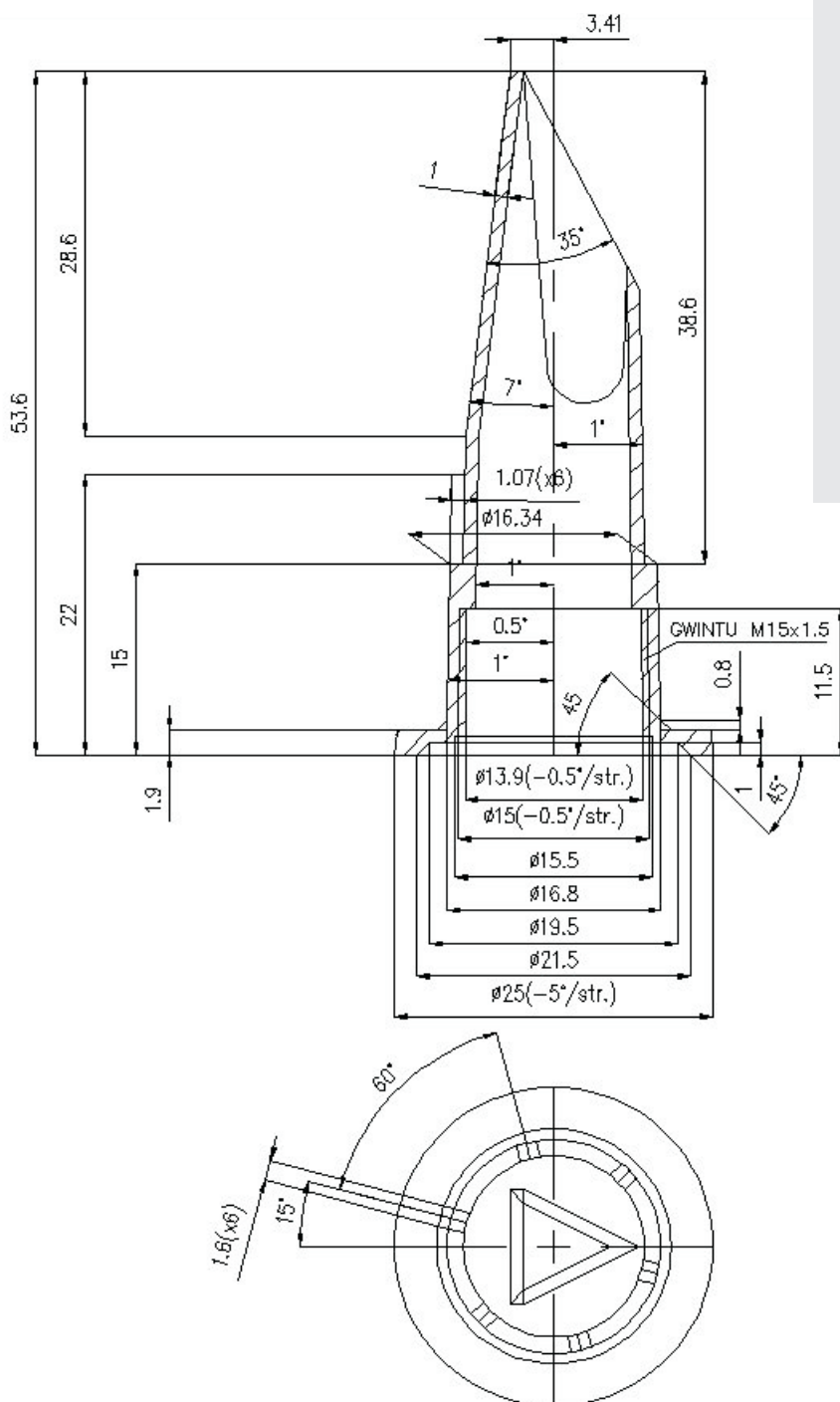

PN-EN ISO 9001:2009



AC 019
QMS



KARTPOL GROUP Sp. z o.o. tel: +48 (22) 787 66 46
ul. Łukasiewicza 11 d tel: +48 (22) 787 65 29
PL 05-200 Wołomin fax: +48 (22) 787 70 55
NIP 125-10-76-610 kartpol@kartpol.eu

Domestic sales:
Aleksandra Borowska
a.borowska@kartpol.eu
ext. 101

Export:
Ewa Kania
e.kania@kartpol.eu
ext. 111

BRE BANK SA
PZL: 43 1140 2062 0000 5317 0200 1001
EUR: PL16 1140 2062 0000 5317 0200 1002
SWIFT (BIC): BREXPLPWWA3
DEUTSCHE BANK PBC S.A.
62 1910 1123 1910 5828 2121 0001 PZL
PL35 1910 1123 1910 5828 2121 0002 EUR
SWIFT (BIC): DEUTPLPK